



3SE3 SIGUARD Position Switches Metal-Enclosed/Open-Type

Description

Application

The function of the position switches (limit switches) is to produce electrical signals corresponding to the positions of the moving machinery.

The 3SE3 position switches can be fitted with snap-action or slow-action contacts. 3SE3 position switches are available with 2, 3 and 4 contacts. The units are suitable for any climate.

Specifications

IEC 60 947-5-1/EN60 947-5-1 and VDE 0660 Part 200.

Positive opening

The 3SE3 2 metal-enclosed position switches with snap-action contacts as well as devices with slow-action contacts can be used as safety position switches in control systems conforming to IEC 60 204-1/EN 60 204-1 and VDE 0113 Part 1. The contacts of the switch are forced open mechanically, positively-driven and reliably by the plunger (positive-opening). In order to ensure this positive opening, the position switch must be actuated in such a way that the nominal travel (pages 8/26 to 8/40) and angle for the positive opening are substantially exceeded.

Design

The 3SE3 position switches are available as metal-enclosed (in die-cast narrow or wide aluminium housings) or open-type units. The wide housing has three Pg 13.5 cable entries, the narrow enclosure has one.

3SE3 position switches with narrow enclosure and overtravel plunger, roller plunger, rod and roller crank actuators conform to EN 50 041. These specifications define the most important fixing dimensions, operating points, enclosure types and actuator types. The 3SE3 open-type position switch is only available with a plunger actuator.

All actuators can be repositioned every $4 \times 90^\circ$ so that the switches can be operated from any of the four sides.

The position switches with roller lever are approached perpendicular to the plunger axis and position switches with angular roller lever are approached in parallel with the plunger axis.

Roller cranks, adjustable-length roller cranks and rod actuators can be continuously adjusted on the shaft.

Important:
The 3SE3 position switches are not permitted to be used as stops.

Technical data

Rated insulation voltage U_i	500 V					
Conventional thermal current I_{th}	10 A					
Pollution degree	Class 3 acc. to DIN VDE 0110					
Rated operational voltage U_e	AC 500 V, over AC 380 V only for equal potential					
Rated operational current I_e	AC 40 to 60 Hz			DC		
	U_e	$I_e/AC-12$	$I_e/AC-15$	U_e	$I_e/DC-12$	$I_e/DC-13$
	V	A	A	V	A	A
	24	10	10	24	10	10
	125	10	10	48	6	4
	230	10	6	110	4	1
	400	10	4	220	1	0.4
	500	10	3	440	0.5	0.2
Short circuit protection ¹⁾ DIAZED-fuse sets	Utilisation category gL/gG: 6 A, quick response: 10 A					
Approved only for metal-enclosed position switches	Ⓢ, Ⓣ and Ⓡ ratings	Conventional thermal current	Rated voltage	Switching capacity:		
		10 A	AC 300 V	Heavy Duty ²⁾ A 600/Q 600 (A 300/Q 300 for 3SE3 ...-8.)		
Mechanical endurance	30 · 10 ⁶ make-break operations					
Electrical endurance	10 · 10 ⁶ make-break operations with 3RH11, 3RT10 16, 3RT10 17, 3RT10 24 to 3RT10 26 (3TH4, 3TF40 to 3TF43) contactors					
• for AC-15 duty	0.5 · 10 ⁶ make-break operations when interrupting $I_e/AC-15$					
• for DC-13 duty	With DC the contact endurance depends not only on the breaking current but also on the voltage, the circuit inductance and the speed of switching.					
	No generally valid information can be given.					
Operating frequency	6 · 10 ³ make-break operations per hour					
Operating point accuracy	0.05 mm for repeated switching, measured at the plunger of the contact block.					
Ambient temperature	-40 to +85 °C (-35 to +85 °C for 3SE3 ...-8.)					
Degree of protection DIN VDE 0470 and IEC 60 529	Open-type position switch	Terminals	IP 20			
		Switching chamber	IP 40			
	Metal-enclosed position switch		IP 67			
	Electrical plug and socket connection		IP 65			
Conductor sizes (M 3.5 screw terminals)						
• finely stranded with end sleeves	2 × 1.5 mm ²					
• solid	2 × 2.5 mm ²					
Enclosure cable entry	Pg 13.5 thread					
Earthing connection	M 3.5 inside enclosure					
Enclosure	Metal (GD - AISi 12)					
Mounting position	any					

1) Fully weld-resistant acc. to DIN VDE 0660 Part 200.

2) See Part 17.

3SE3 100 to 3SE3 150 SIGUARD Position Switches Metal-Enclosed



Selection and ordering data

2 contacts · Moving double break contacts · Degree of protection IP 67 · EN 50 041 · Special width 56 mm

40 mm wide		56 mm wide		3SE3 position switches with 2 slow-action contacts		3SE3 position switches with 2 slow-action contacts		3SE3 position switches with 2 slow-action contacts		Wght. app.
The actuator heads can be subsequently exchanged. 1)		Actuator type	Enclosure width	Identification number 11 acc. to EN 50 013 3SE3 000-0A switch block	Order No.	Identification number 02 acc. to EN 50 013 3SE3 000-6A switch block	Order No.	Identification number 20 acc. to EN 50 013 3SE3 000-7A switch block	Order No.	Price
Actuator		EN 50 041	mm ▶	Preferred type						1 unit
										kg
	Plunger	-	40	→ 3SE3 120-0B	→ 3SE3 120-6B	→ 3SE3 120-7B				0.2
			56	→ 3SE3 100-0B	→ 3SE3 100-6B	→ 3SE3 100-7B				0.23
	Overtravel plunger	B	40 ▶	→ 3SE3 120-0C	→ 3SE3 120-6C	→ 3SE3 120-7C				0.22
			56	→ 3SE3 100-0C	→ 3SE3 100-6C	→ 3SE3 100-7C				0.25
	Roller plunger	C	40 ▶	→ 3SE3 120-0D	→ 3SE3 120-6D	→ 3SE3 120-7D				0.24
			56	→ 3SE3 100-0D	→ 3SE3 100-6D	→ 3SE3 100-7D				0.27
	Roller lever Actuator made from moulded plastic	-	40 ▶	→ 3SE3 120-0E	→ 3SE3 120-6E	→ 3SE3 120-7E				0.22
			56 ▶	→ 3SE3 100-0E	→ 3SE3 100-6E	→ 3SE3 100-7E				0.25
	Angular roller lever Actuator made from moulded plastic	-	40 ▶	→ 3SE3 120-0F	→ 3SE3 120-6F	→ 3SE3 120-7F				0.23
			56	→ 3SE3 100-0F	→ 3SE3 100-6F	→ 3SE3 100-7F				0.25
	Roller crank • finely adjustable from 10° to 10°	A	40 2) ▶	→ 3SE3 120-0GW	→ 3SE3 120-6GW	→ 3SE3 120-7GW				0.3
			56	→ 3SE3 100-0GW	→ 3SE3 100-6GW	→ 3SE3 100-7GW				0.32
	Rod actuator finely adjustable from 10° to 10° • adjustable length, finely adjustable from 10° to 10°	-	40 2)	3SE3 120-0UW	3SE3 120-6UW	3SE3 120-7UW				0.35
			56	3SE3 100-0UW	3SE3 100-6UW	3SE3 100-7UW				0.37
	Rod actuator finely adjustable from 10° to 10° • Moulded-plastic rod • Aluminium rod	D	40 ▶	3SE3 120-0WW	3SE3 120-6WW	3SE3 120-7WW				0.31
			56	3SE3 100-0WW	3SE3 100-6WW	3SE3 100-7WW				0.34
			40	3SE3 120-0VW	3SE3 120-6VW	3SE3 120-7VW				0.32
			56	3SE3 100-0VW	3SE3 100-6VW	3SE3 100-7VW				0.35

Complete combinations 3)

	Snap-action contacts	Slow-action contacts	Slow-action make-before-break contacts	Add. price	Add. wght. app. kg
	Order No. 4)	Order No. 4)	Order No. 4)		
Complete combinations with 3SE3 120 position switches with 3SY3 110 adapter plate, 3SY3 027 base plate with locking lever and 3SY3 111 socket	3SE3 140-1.	3SE3 140-0.	3SE3 140-3.		0.17
Complete combinations with 3SE3 120 position switches and 3SY3 111 socket	3SE3 150-1.	3SE3 150-0.	3SE3 150-3.		0.06

See for special design on pages 8/8 and 8/22.
See for operation, operating speed and travels on pages 8/27 to 8/32.
For multi-unit packing, see Part 17.

→ Safety function according to IEC 60 947-5-1-3 and DIN VDE 0660 Part 200.
□ Design acc. to EN 50 041.

1) See on page 8/23.
2) Special design with large roller, see page 8/8.
3) Not valid for 3SE3 1.0-8.
4) Order No. to be supplemented depending upon the selected actuator. Example: 3SE3 140-1E.



3SE3 100 and 3SE3 120 SIGUARD Position Switches Metal-Enclosed

Selection and ordering data

2 contacts · Moving double break contacts · Degree of protection IP 67 · EN 50 041 · Special width 56 mm

40 mm wide 56 mm wide



The actuator heads can be replaced with other variants later. 1)

3SE3 position switches
with 2 snap-action contacts

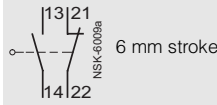

3SE3 position switches
with 2 snap-action contacts

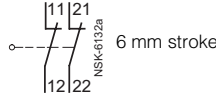

3SE3 position switches
with 2 slow-action make-before-break contacts



Actuator	Actuator type	Fig. No.	Enclosure width	3SE3 position switches with 2 snap-action contacts		3SE3 position switches with 2 snap-action contacts		3SE3 position switches with 2 slow-action make-before-break contacts		Wght app. kg
				Order No.	Price	Order No.	Price	Order No.	Price	
			mm	EN 50 041	Preferred type	1 unit	1 unit	1 unit	1 unit	kg
1	Plunger	1	40	→	3SE3 120-1B	-	-	→	3SE3 120-3B	0.2
			56	→	3SE3 100-1B	-	-	→	3SE3 100-3B	0.23
2	Overtravel plunger B	2	40	→	3SE3 120-1C	→	3SE3 120-8C	→	3SE3 120-3C	0.22
			56	→	3SE3 100-1C	→	3SE3 100-8C	→	3SE3 100-3C	0.25
3	Roller plunger	C	40	→	3SE3 120-1D	→	3SE3 120-8D	→	3SE3 120-3D	0.24
			56	→	3SE3 100-1D	→	3SE3 100-8D	→	3SE3 100-3D	0.27
4	Roller lever Actuator made from moulded-plastic	-	40	→	3SE3 120-1E	→	3SE3 120-8E	→	3SE3 120-3E	0.22
			56	→	3SE3 100-1E	→	3SE3 100-8E	→	3SE3 100-3E	0.25
5	Angular roller lever Actuator made from moulded-plastic	-	40	→	3SE3 120-1F	→	3SE3 120-8F	→	3SE3 120-3F	0.23
			56	→	3SE3 100-1F	→	3SE3 100-8F	→	3SE3 100-3F	0.25
6	Roller crank • finely adjustable from 10° to 10°	A	40 ³⁾	→	3SE3 120-1GW	→	3SE3 120-8GW	→	3SE3 120-3GW	0.3
			56	→	3SE3 100-1GW	→	3SE3 100-8GW	→	3SE3 100-3GW	0.32
7	• adjustment-length, finely adjustable from 10° to 10°	-	40 ³⁾	→	3SE3 120-1UW	→	3SE3 120-8UW	→	3SE3 120-3UW	0.35
			56	→	3SE3 100-1UW	→	3SE3 100-8UW	→	3SE3 100-3UW	0.37
8	Rod actuator finely adjustable from 10° to 10°	D	8							
	• Moulded-plastic rod		40	→	3SE3 120-1WW	→	3SE3 120-8WW	→	3SE3 120-3WW	0.35
			56	→	3SE3 100-1WW	→	3SE3 100-8WW	→	3SE3 100-3WW	0.37
	• Aluminium rod		40	→	3SE3 120-1VW	→	3SE3 120-8VW	→	3SE3 120-3VW	0.35
			56	→	3SE3 100-1VW	→	3SE3 100-8VW	→	3SE3 100-3VW	0.37
9	Spring rod	-	40		3SE3 120-1R	-	-	-	-	0.23
			56		3SE3 100-1R	-	-	-	-	0.25
10	Fork lever	-	40		3SE3 120-1T	-	-	-	-	0.3
			56		3SE3 100-1T	-	-	-	-	0.32
11	Overtravel plunger side operation	-	40	→	3SE3 120-1XP	-	-	-	-	0.27
12	Roller plunger with roller • in vertical direction side operation	-	40	→	3SE3 120-1XQ	-	-	-	-	0.28
13	• in horizontal direction side operation	-	40	→	3SE3 120-1XR	-	-	-	-	0.28

See for special design on pages 8/8 and 8/22.
See for operation, operating speed and travel on pages 8/27 to 8/33.
For multi-unit packing, see Part 17.

→ Safety function according to IEC 60 947-5-1-3 and DIN VDE 0660 Part 200.
Design acc. to EN 50 041.









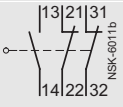
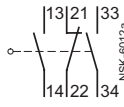
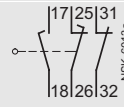
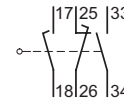

1) See page 8/23.
2) Switch block 3SE3 000-1A is not valid for 3SE3 120-1XP/-1XQ/-1XR and 3SE3 1.0-8.
3) Special design with large roller see page 8/8.

3SE3 303 SIGUARD Position Switches Metal-Enclosed



Selection and ordering data

3 contacts · Wide enclosure · Moving double break contacts · Degree of protection IP 67

56 mm wide 	3SE3 position switches	3SE3 position switches	3SE3 position switches	3SE3 position switches	Wght. app.
	with mit 3 slow-action contacts	with 3 slow-action contacts	with 3 slow-action make-before-break contacts	with 3 slow-action make-before-break contacts	
	 6 mm stroke Identification number 12 acc. to EN 50 013, 3SE3 003-0A switch block	 6 mm stroke Identification number 21 acc. to EN 50 013, 3SE3 003-1A switch block	 6 mm stroke Identification number 12 acc. to EN 50 013, 3SE3 003-2A switch block	 6 mm stroke Identification number 21 acc. to EN 50 013, 3SE3 003-3A switch block	
	Order No.	Order No.	Order No.	Order No.	Price
<i>Actuator</i> ▶	Preferred type				1 unit kg
 <i>Plunger</i>	→ 3SE3 303-0B	→ 3SE3 303-1B	→ 3SE3 303-2B	→ 3SE3 303-3B	0.31
 <i>Overtravel plunger</i>	→ 3SE3 303-0C	→ 3SE3 303-1C	→ 3SE3 303-2C	→ 3SE3 303-3C	0.33
 <i>Roller plunger</i>	→ 3SE3 303-0D	→ 3SE3 303-1D	→ 3SE3 303-2D	→ 3SE3 303-3D	0.35
 <i>Roller lever</i> Actuator made from moulded plastic	→ 3SE3 303-0E	→ 3SE3 303-1E	→ 3SE3 303-2E	→ 3SE3 303-3E	0.33
 <i>Angular roller lever</i> Actuator made from moulded plastic	→ 3SE3 303-0F	→ 3SE3 303-1F	→ 3SE3 303-2F	→ 3SE3 303-3F	0.33
 <i>Roller crank</i> • finely adjustable from 10° to 10°	→ 3SE3 303-0GW	→ 3SE3 303-1GW	→ 3SE3 303-2GW	→ 3SE3 303-3GW	0.41
 <i>Rod actuator</i> • adjustable length, finely adjustable from 10° to 10°	3SE3 303-0UW	3SE3 303-1UW	3SE3 303-2UW	3SE3 303-3UW	0.46
 <i>Rod actuator</i> finely adjustable from 10° to 10°	3SE3 303-0WW	3SE3 303-1WW	3SE3 303-2WW	3SE3 303-3WW	0.42
 <i>Rod actuator</i> finely adjustable from 10° to 10°	3SE3 303-0VW	3SE3 303-1VW	3SE3 303-2VW	3SE3 303-3VW	0.43

Special designs for 3SE3 303 and 3SE3 404 metal-enclosed position switches

Ordering advice:	Design	Order No.	Add. price
When ordering special designs, suffix the Order No. with „-Z“ and the order code. Example: 3SE3 303-1E-Z A01	with increased corrosion protection The enclosure is double-painted. All parts subject to corrosion are made of stainless steel. with steel roller (no corrosion) For position switches with roller plunger, roller lever, angular roller lever, finely and length adjustable roller cranks, fork lever.	A01 A16	

See for special design on pages 8/8 and 8/22.
See for operation, operating speed and travels on pages 8/34 to 8/40.
For multi-unit packing, see Part 17.

→ Safety function according to IEC 60 947-5-1-3 and DIN VDE 0660 Part 200.



3SE3 404 SIGUARD Position Switches Metal-Enclosed

Selection and ordering data

4 contacts · Wide enclosure · Moving double-break contacts · Degree of protection IP 67

56 mm wide



3SE3 position switches

with 4 snap-action contacts

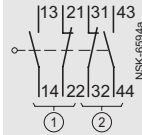

6 mm stroke

Identification number **22**
acc. to EN 50 013
① Switch block
3SE3 000-1A
② Switch block
3SE3 010-1A

3SE3 position switches

with 4 slow-action contacts

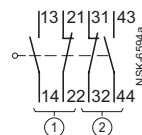

6 mm stroke

Identification number **22**
acc. to EN 50 013
① Switch block
3SE3 000-0A
② Switch block
3SE3 010-0A

3SE3 position switches

with 4 slow-action make-before-break contacts

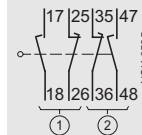

6 mm stroke

Identification number **22**
acc. to EN 50 013
① Switch block
3SE3 000-3A
② Switch block
3SE3 010-3A

Wght.
approx.

		Order No.	Order No.	Order No.	Price 1 unit	kg
	<i>Plunger</i>	→ 3SE3 404-1B	→ 3SE3 404-0B	→ 3SE3 404-2B		0.38
	<i>Overtravel plunger</i>	→ 3SE3 404-1C	→ 3SE3 404-0C	→ 3SE3 404-2C		0.4
	<i>Roller plunger</i>	→ 3SE3 404-1D	→ 3SE3 404-0D	→ 3SE3 404-2D		0.42
	<i>Roller lever</i> Actuator made from moulded-plastic	→ 3SE3 404-1E	→ 3SE3 404-0E	→ 3SE3 404-2E		0.4
	<i>Angular roller lever</i> Actuator made from moulded-plastic	→ 3SE3 404-1F	→ 3SE3 404-0F	→ 3SE3 404-2F		0.4
	<i>Roller crank</i> • finely adjustable from 10° to 10°	→ 3SE3 404-1GW	→ 3SE3 404-0GW	→ 3SE3 404-2GW		0.48
	<i>Rod actuator</i> • length adjustable, finely adjustable from 10° to 10°	3SE3 404-1UW	→ 3SE3 404-0UW	→ 3SE3 404-2UW		0.54
	<i>Rod actuator</i> finely adjustable from 10° to 10° • Moulded-plastic rod • Aluminium rod	3SE3 404-1WW 3SE3 404-1VW	→ 3SE3 404-0WW 3SE3 404-0VW	→ 3SE3 404-2WW 3SE3 404-2VW		0.49 0.5
	<i>Fork lever</i>	3SE3 404-1T	–	–		0.49

Both elements switch synchronously when two 3SE3 000-.. elements are connected.

See for special designs on pages 8/8, 8/20 and 8/22. See for operation, operating speed and travel on page 8/40. For multi-unit packing, see Part 17.

→ Safety function according to IEC 60 947-5-1-3 and DIN VDE 0660 Part 200.

3SE3 SIGUARD Position Switches

Moulded-Plastic/Metal-Enclosed





Selection and ordering data

Special designs for 3SE3 100 and 3SE3 120¹⁾ metal-enclosed position switches

Notes on ordering:	Design	Roller diameter	Order code	Add. price
When ordering special designs, supplement the Order No. with „Z“ and with the Order Code. Example: 3SE3 100-1E-Z A01	With increased corrosion protection The housing is double-painted, all parts subject to corrosion are made of stainless steel.		A01	
	With metal roller For position switches with roller plunger, roller lever, angular roller lever, repositionable and finely and length adjustable roller cranks, fork lever.		A16	
	With moulded-plastic roller for 3SE3 100-.GW, -.UW and 3SE3 120-.GW, -.UW	30 mm	A20	
		50 mm	A22	
	With rubber roller for 3SE3 100-.GW, -.UW and 3SE3 120-.GW, -.UW	50 mm	A23	
Design only for 3SE3 120²⁾				
	With built-in indicator light with glow lamp AC 230 V with LED UC 24 V		A03	
		green	A10	
		green and yellow	A32	
3SE3 120 metal-enclosed position switches can be equipped with LEDs in the cover for status indication.	Two versions are available with one or two LEDs respectively. Failure of the operational voltage can therefore be visually	indicated as well as the switching status.		

Special designs for 3SE3 moulded-plastic and metal-enclosed position switches

Notes on ordering:	Design	Order code	Add. price
When ordering special designs, supplement the Order No. with „Z“ and with the Order Code. Example: 3SE3 120-1GW-Z C01	Direct connection to AS-Interface for all switch types with Pg 13.5 screw gland	C01	
	3SE3 120 -1GW		
	Communication capability can be granted to all switch types with Pg 13.5 screw glands with this adapter module. For signalling and diagnostic purposes, the NO contact is directly connected to the AS-i bus.	Safety functions can be wired conventionally through the adapter module.	The yellow bus cable is routed past the switch through the AS-i connection terminal.
			

1) Not valid for 3SE3 1.0-8.
 2) Not for safety circuits.















3SE3 SIGUARD Position Switches Metal-Enclosed

Accessories

Actuator heads for 3SE3 position switches

The actuator heads of the position switches can be subsequently exchanged¹⁾.

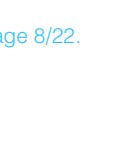
1	2	Actuator with fixing screws	Fig. No.	For position switches 3SE3 ...-□□□	Order No.	Price 1 unit	Weight approx. kg	Packing Units
		Plunger with screws and gasket	1	-0B -1B -3B	3SX3 100		0.025	Packed in ordered quantity
		Overtravel plunger with screws and gasket	2	-.C	3SX3 106		0.045	
		Roller plunger with screws and gasket	3	-.D	3SX3 107		0.065	
		Roller lever with screws and gasket	4	-0E -1E -3E	3SX3 102		0.045	
		Angular roller lever with screws and gasket	5	-0F -1F -3F	3SX3 104		0.05	Packed in ordered quantity
		Actuator head • with round spindle, with screws and gasket • for fork lever	6	-.GW -.JW -.VW -.WW	3SX3 211		0.105	
		Roller crank 30 mm for round spindle	7	-1T	3SX3 127		0.105	
		Fork lever	8	-1T	3SX3 115		0.03	Packed in ordered quantity
		Roller rod adjustable length	-	-.UW	3SY3 024		0.054	
		Rod actuator Plastic rod	-	-.WW	3SX3 000		0.03	
		Aluminium rod	-	-.VW	3SX3 001		0.04	
		Roller crank with clamp adjustable length	9	-.JW	3SX3 213		0.11	Packed in ordered quantity
		Spring rod with screws and gasket	10	-1R	3SX3 126		0.05	
		Lamp holder complete • with glow lamp AC 230 V • with LED (green) UC 24 V • with LED (green, yellow) UC 24V	-	3SE3 120	3SX3 135		0.005	Packed in ordered quantity
		Cover with lens, clear for narrow enclosure	-	3SE3 120	3SX3 137		0.05	

Special design see on page 8/22.

1) Not valid for safety position switches
3SE3 120-0XB and 3SE3 ...-8.









3SE3 SIGUARD Position Switches

Moulded-Plastic/Metal-Enclosed



Accessories

Quick-release devices and plug connectors
for fast installation and replacement of position switches

Design		Fig. No.	Order No.	Price	Weight approx.	Packing
				1 unit	kg	Units
For types 3SE3 120 and 3SE3 230						
		1	3SY3 110		0.03	Packed in ordered quantity
		2	3SY3 027		0.08	
		3	3SY3 111		0.06	
		4	3SX6 237		0.05	
		5	3SY3 122		0.05	
		6	3SY3 123		0.05	
		–	3SY3 125		0.02	
		–	3SY3 126		0.02	
		–	3RX1 505		0.05	
		–	3SB19 02-2AE		0.01	
		7	3SX9 910		0.1	
		8	3SY3 124		0.01	

1) Using a crimping tool for wiring max. conductor size 1 mm².



3SE3 SIGUARD Position Switches Moulded-Plastic/Metal-Enclosed

Spare parts¹⁾

		for position switches	Fig No.	Order No.	Price	Weight approx. kg	Packing Unit
				Preferred type	1 unit		
1	2	Switch blocks with 2 contacts with moving double-break contacts with					
		Snap-action contacts 1 NO + 1 NC	3SE3 1.0-1.. 3SE3 230, 3SE3 404-1	1	▶ 3SE3 000-1A		0.03
		Slow-action contacts 1 NO + 1 NC	3SE3 1.0-0.. 3SE3 230, 3SE3 404-0	2	▶ 3SE3 000-0A	0.03	5
3		2 NC 2 NO	3SE3 1.0-6.. 3SE3 1.0-7..		3SE3 000-6A 3SE3 000-7A	0.03 0.03	5 5
		Slow-action make- before-break contacts 1 NO + 1 NC	3SE3 1.0-3.. 3SE3 230, 3SE3 404-2	2	3SE3 000-3A	0.03	5
	Switch blocks with 3 contacts with moving double-break contacts with						
		Slow-action contacts 1 NO + 2 NC 2 NO + 1 NC	3SE3 303-0. 3SE3 303-1.	3 3	3SE3 003-0A 3SE3 003-1A	0.05 0.05	5 5
		Slow-action make- before-break contacts 1 NO + 2 NC 2 NO + 1 NC	3SE3 303-2. 3SE3 303-3.	3 3	3SE3 003-2A 3SE3 003-3A	0.05 0.05	5 5
4	5	Switch blocks with repeat plunger with 2 contacts, for position switches with 4 contacts with moving double-break contacts with					
		Snap-action contacts	3SE3 404-1.	4	3SE3 010-1A		0.035
		Slow-action contacts	3SE3 404-0.	5	3SE3 010-0A	0.035	5
		Slow-action make- before-break contacts	3SE3 404-2.	5	3SE3 010-3A	0.035	5

1) Not valid for 3SE3 ...-8.





3SE3 SIGUARD Position Switches

Open-Type



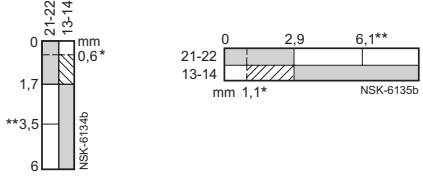

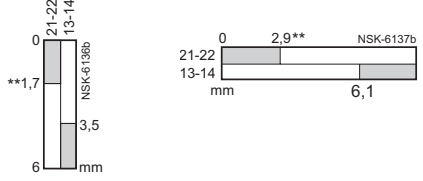
Selection and ordering data

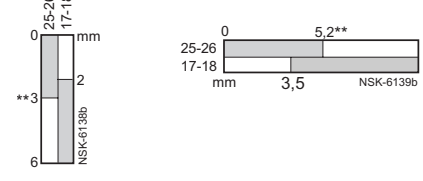
2 contacts · Moving double break contacts · Degree of protection: Terminals IP 20, switching chamber IP 40
 Tandem arrangement (2 × 2 contacts) is possible when 3SY3 121 adapter is used, see accessories below.

Internal circuit diagram Terminal designation acc. to EN 50 013	Order No.	Price	Weight approx.	Packing	Nominal travel and related terminals	Minimum force required along plunger axis
	▶ Preferred type	1 unit	kg	Unit	along plunger perpendicular to plunger axis $\alpha = 30^\circ$	
Snap-action contacts, 6 mm stroke						
3SE3 020-1A  Terminal diagram: 13 21, 14 22 (NSK-6009a)	with 21 mm long plunger ▶ 3SE3 020-1A		0.035	5		6 N
Slow-action contacts, 6 mm stroke						
3SE3 020-0A  Terminal diagram: 21 13, 22 14 (NSK-6038)	with 21 mm long plunger ▶ 3SE3 020-0A		0.035	5		8 N
Slow-action make-before-break contacts, 6 mm stroke						
3SE 020-3A  Terminal diagram: 17 25, 18 26 (NSK-6010a)	with 21 mm long plunger ▶ 3SE3 020-3A		0.035	5		8 N
	3SY3 121				Intermediate piece for tandem allocation of 2-pole open-type position switches	
	3SY3 121				packed depending on quantity ordered	

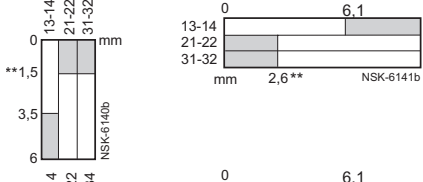
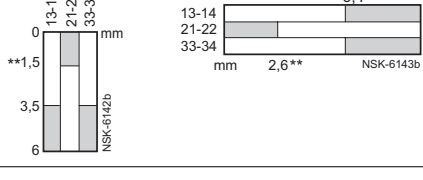
3 contacts · Moving double break contacts · Degree of protection: Terminals IP 20, switching chamber IP 40

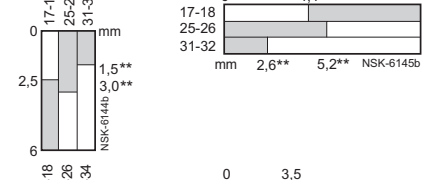
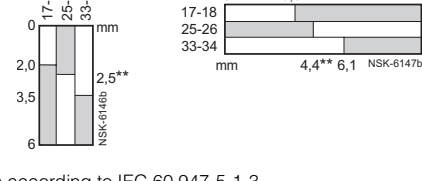
Slow-action contacts, 6 mm stroke						
3SE3 023-0A  Terminal diagram: 13 21 31, 14 22 32 (NSK-6011b)	with 21 mm long plunger and repeat plunger for tandem arrangement ▶ 3SE3 023-0A		0.055	5		11 N
	▶ 3SE3 023-1A		0.055	5		13 N
Slow-action make-before-break contacts, 6 mm stroke						
3SE3 023-2A  Terminal diagram: 17 25 31, 18 26 32 (NSK-6013a)	with 21 mm long plunger and repeat plunger for tandem arrangement ▶ 3SE3 023-2A		0.055	5		11 N
	▶ 3SE3 023-3A		0.055	5		13 N

⤵ Safety function according to IEC 60 947-5-1-3 and DIN VDE 0660 Teil 200.

See for operating and travel on page 8/40.



3SE3 100, 3SE3 120 SIGUARD Position Switches Metal-Enclosed

Operation, operating speed and travel or angle of actuators



2 contacts · Narrow and wide enclosure

Bars, cams, stops, etc. are used as actuating devices. The shape of the actuating device must provide the given angles for the leading and trailing edges. For operation from the side,

sparingly greased steel, POM (polyoxymethylene or polyacetal) or PA (polyamide) should be used as cam and bar material.

Operating speed along plunger axis

The operating speed must not be less than 15 mm/s for position switches (limit switches) with slow-action contacts at

DC voltage and 1 mm/s at AC voltage. Position switches with snap-action contacts should be used when the speeds are lower.

Operation by a bar	Switch blocks	Nominal travel and rated terminals	Switch blocks	Nominal travel
⊙ operating point acc. to EN 50 041 v_{max} max. operating speed H travel difference → direction of operation	Internal circuit diagram Terminal designation acc. to EN 50 013	0-line reference line to EN 50 041 travel acc. to EN 50 041 S contact closed □ contact open * operating point on return ** positive opening acc. to IEC 60 947-5-1-3		

Plunger

(made from CrNi)

3SE3 ..0-B

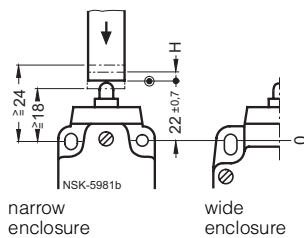

$v_{max} = 1.5$ m/s

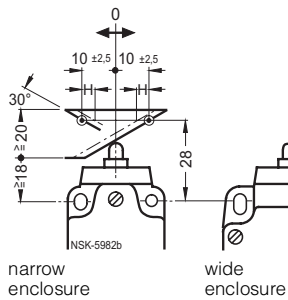

$v_{max} = 0.5$ m/s

Minimum force required in direction of operation: 12 N

Slow-action contacts

1 NO + 1 NC

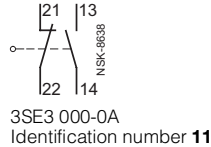

along plunger axis

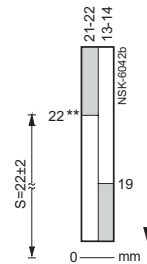

perpendicular to plunger axis

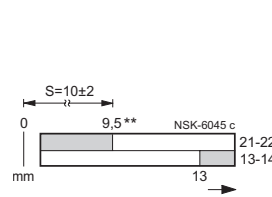

2 NC

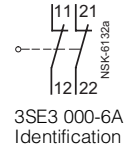

along plunger axis

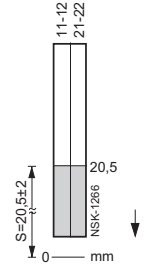

with make-before-break

1 NO + 1 NC

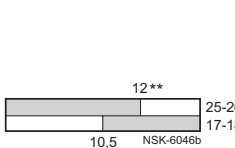
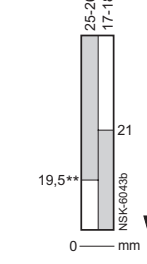
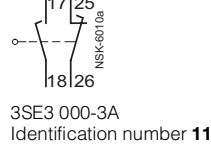

2 NO

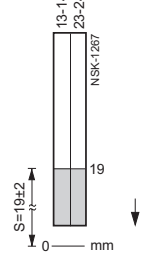
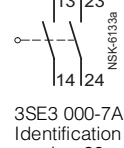

Snap-action contacts

1 NO + 1 NC

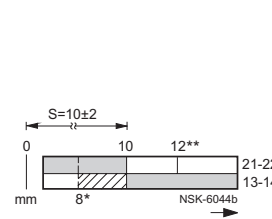
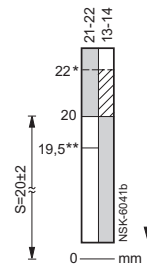
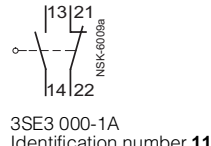

3SE3 100, 3SE3 120, 3SE3 230 SIGUARD Position Switches

Moulded-Plastic/Metal-Enclosed



Operation, operating speed and travel or angle of actuators

2 contacts · Narrow and wide enclosure

Operation by a bar	Switch blocks	Nominal travel and associated terminals	Switch blocks	Nominal travel
<ul style="list-style-type: none"> ⊙ operating point acc. to EN 50 041 v_{max.} max. operation speed H travel difference → direction of operation 	<ul style="list-style-type: none"> Internal circuit diagram Terminal designation acc. to EN 50 013 	<ul style="list-style-type: none"> 0-line reference line acc. to EN 50 041 S travel acc. to EN 50 041 ■ contact closed □ contact open * operating point on return ** positive opening acc. to IEC 60 947-5-1-3 		

Overtravel plunger

(made from CrNi)

3SE3 ...-C

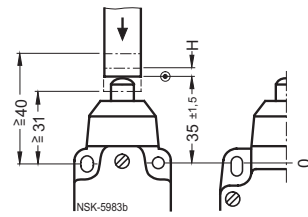

narrow enclosure wide enclosure

v_{max.} = 1.5 m/s

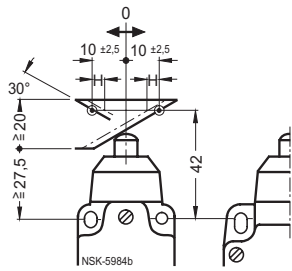

narrow enclosure wide enclosure

v_{max.} = 0.5 m/s

Minimum force required in direction of operation: 32 N

Slow-action contacts

1 NO + 1 NC

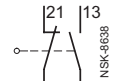

3SE3 000-0A
Identification number **11**

along plunger axis

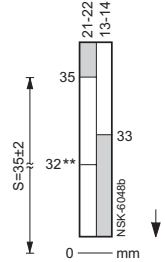

perpendicular to plunger axis

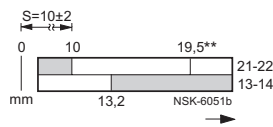

along plunger axis

2 NC

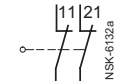

3SE3 000-6A
Identification number **02**

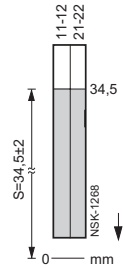

with make-before-break

1 NO + 1 NC

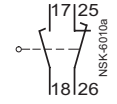

3SE3 000-3A
Identification number **11**

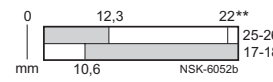
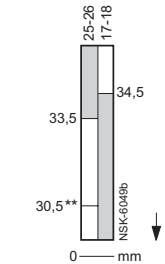

2 NO

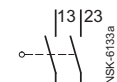

3SE3 000-7A
Identification number **20**

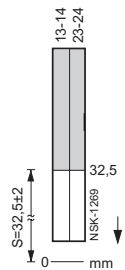

Snap-action contacts

1 NO + 1 NC

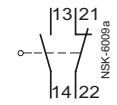

3SE3 000-1A
Identification number **11**

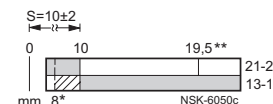
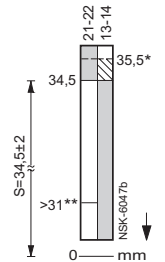

2 NC

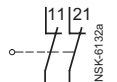

Identification number **02**

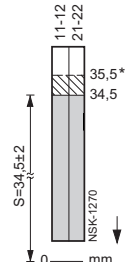



3SE3 100, 3SE3 120, 3SE3 230 SIGUARD Position Switches Moulded-Plastic/Metal-Enclosed

Operation, operating speed and travel or angle of actuators



2 contacts · Narrow and wide enclosure

Operation by a bar	Switch blocks	Nominal travel and related terminals	Switch blocks	Nominal travel
<ul style="list-style-type: none"> ⊙ operating point acc. to EN 50 041 v_{max.} max. operating speed H travel difference → direction of operation 	<ul style="list-style-type: none"> Internal circuit diagram Terminal designation acc. to EN 50 013 	<ul style="list-style-type: none"> 0-line reference line acc. to EN 50 041 S travel acc. to EN 50 041 ▬ contact closed □ contact open * operating point on return ** positive opening acc. to IEC 60 947-5-1-3 		

Roller plunger

(roller made from brass on a steel spindle)

3SE3 100-D 3SE3 120-D

(roller made from moulded plastic on a brass spindle)

3SE3 230-D

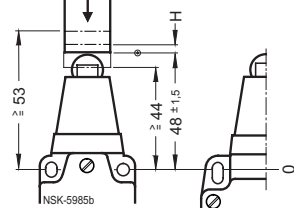

narrow enclosure
v_{max.} = 1.5 m/s

wide enclosure

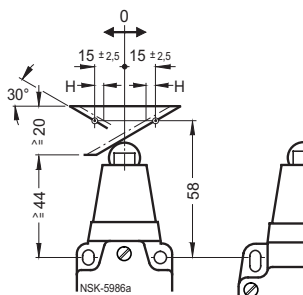

narrow enclosure

wide enclosure

v_{max.} = 1 m/s (3SE3 230-D)
v_{max.} = 0.5 m/s (3SE3 1.0-D)

Minimum force required in direction of operation: 32 N

Slow-action contacts

along plunger axis

perpendicular to plunger axis

along plunger axis

1 NO + 1 NC

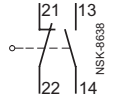

3SE3 000-0A
Identification number **11**

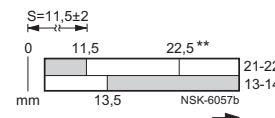
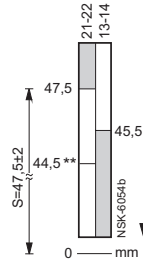

2 NC

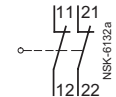

3SE3 000-6A
Identification number **02**

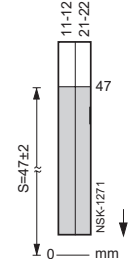

with make-before-break

1 NO + 1 NC

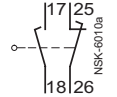

3SE3 000-3A
Identification number **11**

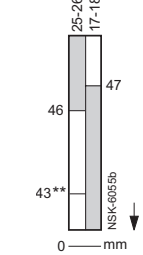

2 NO

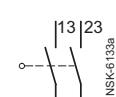

3SE3 000-7A
Identification number **20**

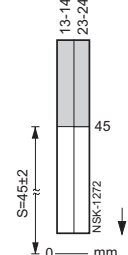

Snap-action contacts

1 NO + 1 NC

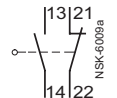

3SE3 000-1A
Identification number **11**

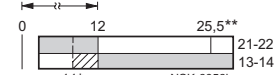
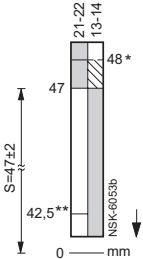

2 NC

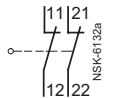

Identification number **02**

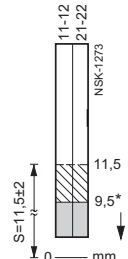

3SE3 100, 3SE3 120, 3SE3 230 SIGUARD Position Switches

Moulded-Plastic/Metal-Enclosed



Operation, operating speed and travel or angle of actuators

2 contacts · Narrow and wide enclosure

Operation by a bar	Switch blocks	Nominal travel and related terminals	Switch blocks	Nominal travel
<ul style="list-style-type: none"> ⊙ operating point acc. to EN 50 041 α max. approach angle γ max. trailing angle V_{max.} max. operating speed H travel difference → direction of operation 	Internal circuit diagram Terminal designation acc. to EN 50 013	S * travel acc. to EN 50041 ** operating point on return positive opening acc. to IEC 60 947-5-1-3	0-line reference line acc. to EN 50 041 	

Roller lever

(roller made from moulded plastic) **3SE3 ...-E**

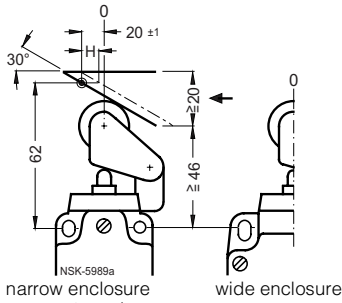

narrow enclosure
V_{max.} = 2.5 m/s

wide enclosure

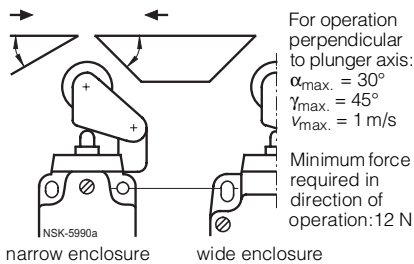

narrow enclosure

wide enclosure

Slow-action contacts

perpendicular to plunger axis

perpendicular to plunger axis

1 NO + 1 NC

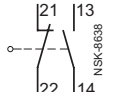

3SE3 000-0A
Identification number **11**

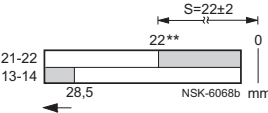

with make-before-break

1 NO + 1 NC

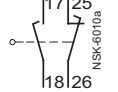

3SE3 000-3A
Identification number **11**

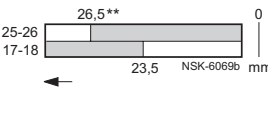

2 NC

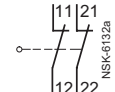

3SE3 000-6A
Identification number **02**

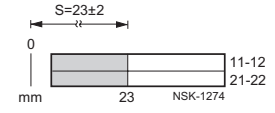

2 NO

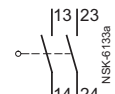

3SE3 000-7A
Identification number **20**

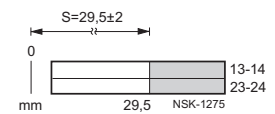

Snap-action contacts

1 NO + 1 NC

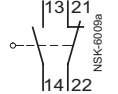

3SE3 000-1A
Identification number **11**

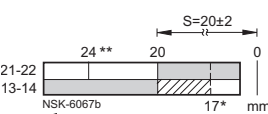

2 NC

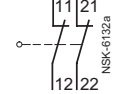

Identification number **02**

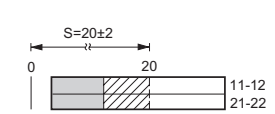

Angular roller lever

(roller made of moulded plastic) **3SE3 ...-F**

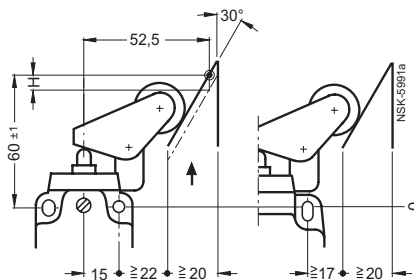

narrow enclosure
V_{max.} = 2.5 m/s

wide enclosure

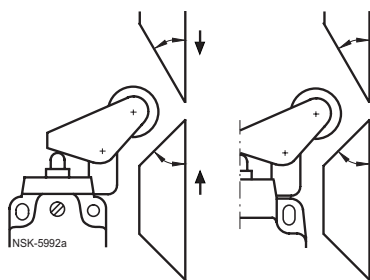

narrow enclosure

wide enclosure

For operation along plunger axis:
α_{max.} = 30° V_{max.} = 1 m/s
γ_{max.} = 45°

Minimum force required in direction of operation: 12 N

Slow-action contacts

along plunger axis

along plunger axis

1 NO + 1 NC

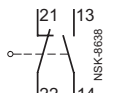

3SE3 000-0A
Identification number **11**

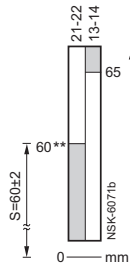

2 NC

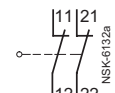

3SE3 000-6A
Identification number **02**

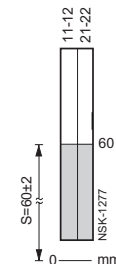

with make-before-break

1 NO + 1 NC

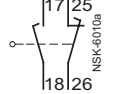

3SE3 000-3A
Identification number **11**

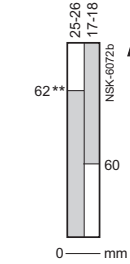

2 NO

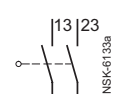

3SE3 000-7A
Identification number **20**

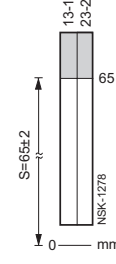

Snap-action contacts

1 NO + 1 NC

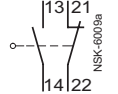

3SE3 000-1A
Identification number **11**

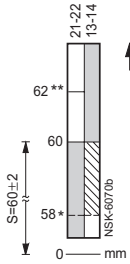

2 NC

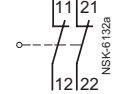

Identification number **02**

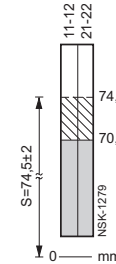



3SE3 100, 3SE3 120, 3SE3 230 SIGUARD Position Switches Moulded-Plastic/Metal-Enclosed

Operation, operating speed and travel or angle of actuators

2 contacts · Narrow and wide enclosure

Operation by a bar	Switch blocks	Nominal travel and related terminals	Switch blocks	Nominal travel
Ⓞ operating point acc. to EN 50 041 α max. approach angle β max. trailing angle v _{max.} max. operating speed ** max. bar distance or angle to ensure positive opening of snap-action contacts acc. to DIN VDE 0113 S travel acc. to EN 50 041 H travel difference → direction of operation	Internal circuit diagram Terminal designation acc. to EN 50 013	S* travel acc. to EN 50 041 operating point on return positive opening acc. to IEC 60 947-5-1-3 **	0-line 	reference line acc. to EN 50 041 contact closed contact open

Roller crank

repositionable and finely adjustable from 10° to 10° (roller made from moulded plastic)

3SE3 ...-GW-Z A31

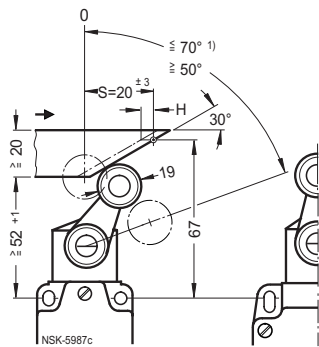

narrow enclosure wide enclosure

v_{max.} = 3 m/s

Contact operation by special designs either from right or left.

Minimum torque in direction of operation: 25 Ncm

Slow-action contacts

1 NO + 1 NC

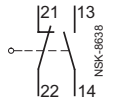

3SE3 000-0A
Identification number 11

perpendicular to plunger axis

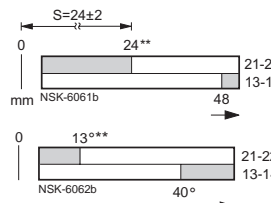

2 NC



3SE3 000-6A
Identification number 02

perpendicular to plunger axis

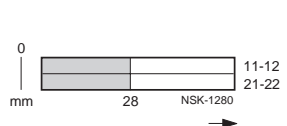

with make-before-break

1 NO + 1 NC

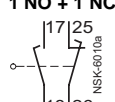

3SE3 000-3A
Identification number 11

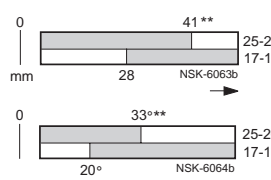

2 NO



3SE3 000-7A
Identification number 20

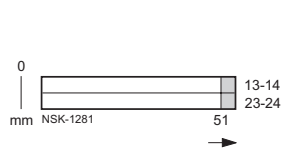

Snap-action contacts

1 NO + 1 NC

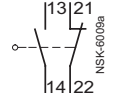

3SE3 000-1A
Identification number 11

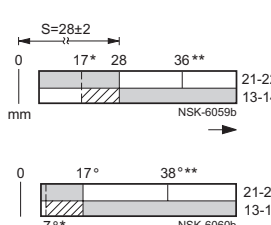

Roller crank

adjustable length (roller made from moulded plastic), finely adjustable from 10° to 10°

3SE3 230-U, 3SE3 1...-UW

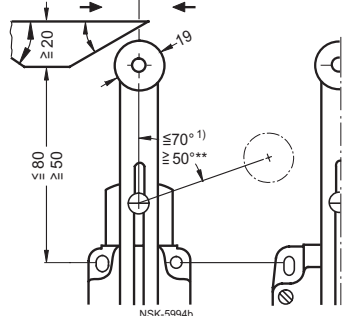

narrow enclosure wide enclosure

α_{max.} = 30° β_{max.} = 30° v_{max.} = 3 m/s

Contact operation either from right or left or from right and left

Minimum torque in direction of operation: 25 Ncm

1) Max. operating angle 70°.

Slow-action contacts

1 NO + 1 NC

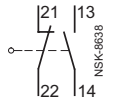

3SE3 000-0A
Identification number 11

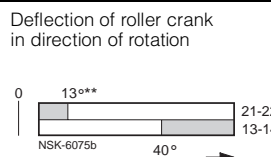

2 NC

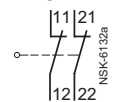

3SE3 000-6A
Identification number 02

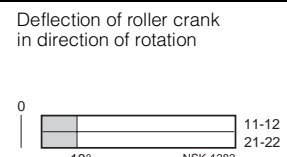

with make-before-break

1 NO + 1 NC

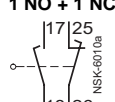

3SE3 000-3A
Identification number 11

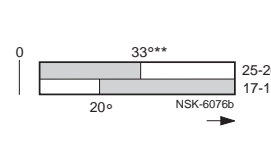

2 NO



3SE3 000-7A
Identification number 20

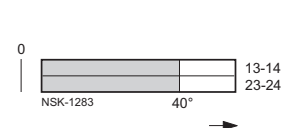

Snap-action contacts

1 NO + 1 NC

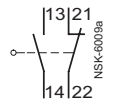

3SE3 000-1A
Identification number 11

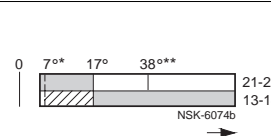

3SE3 100, 3SE3 120, 3SE3 230 SIGUARD Position Switches

Moulded-Plastic/Metal-Enclosed



Operation, operating speed and travel or angle of actuators

2 contacts · Narrow and wide enclosure

Operation by a bar		Switch blocks	Nominal travel and related terminals	Switch blocks	Nominal travel
⊙	operating point acc. to EN 50 041	Internal circuit diagram	S	0-line	reference line acc. to EN 50 041
$v_{max.}$	max. operating speed	Terminal designation acc. to EN 50 013	*		contact closed
→	direction of operation		**		contact open

Rod actuator

(made from aluminium or moulded plastic)
finely adjustable from 10° to 10°

- 3SE3 230-.W
- 3SE3 230-.V
- 3SE3 1...-WW
- 3SE3 1...-VW

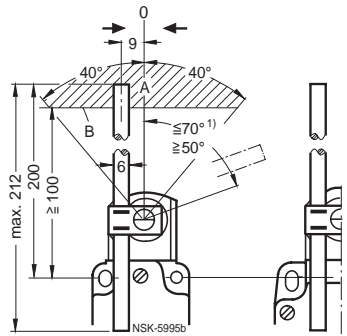

A switching range
B bottom edge of actuating device
 $v_{max.} = 3 \text{ m/s}$

Contact operation either from right or left
or from right and left

Minimum force required
in direction of operation: 25 Ncm

Slow-action contacts

1 NO + 1 NC

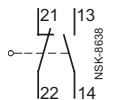

3SE3 000-0A
Identification number **11**

with make-before-break

1 NO + 1 NC

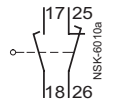

3SE3 000-3A
Identification number **11**

perpendicular to plunger axis

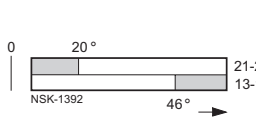

2 NC

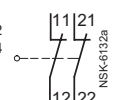

3SE3 000-6A
Identification number **02**

perpendicular to plunger axis

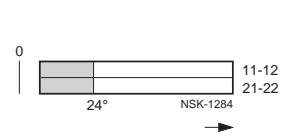

2 NO



3SE3 000-7A
Identification number **20**

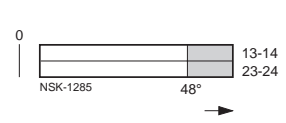

Snap-action contacts

1 NO + 1 NC

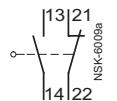

3SE3 000-1A
Identification number **11**

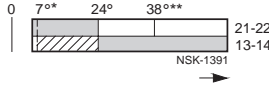

Spring rod

3SE3 ...-1R

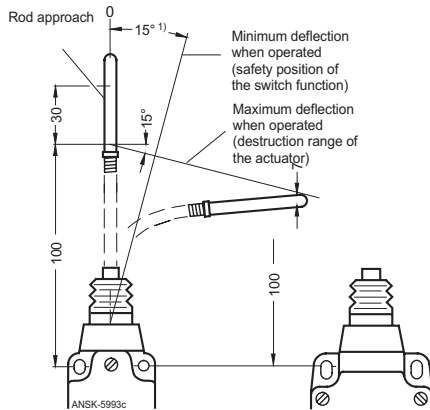

Can be approached from any direction
 $v_{max.} = 1 \text{ m/s}$

Minimum force required
along plunger: 12 N

With side deflection on the peak: 2.5 N

Snap-action contacts

1 NO + 1 NC

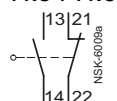

3SE3 000-1A
Identification number **11**

Deflection of spring rod

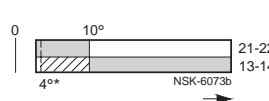

1) Max. operating angle 70°.



3SE3 100, 3SE3 120 SIGUARD Position Switches Metal-Enclosed

Operation, operating speed
and travel or angle

2 contacts · Narrow and wide enclosure

Actuator	Operation by a bar	Switch block	Nominal travel and related terminals	Minimum force required in direction of operation
	v_{max} max. operating speed → direction of operation	Internal circuit diagram Terminal designation acc. to EN 50 013	0-line reference line acc. to EN 50 041 ■ contact closed □ contact open * operating point on return	

Fork lever

(roller made from moulded plastic)

3SE3 100-1T,
3SE3 120-1T

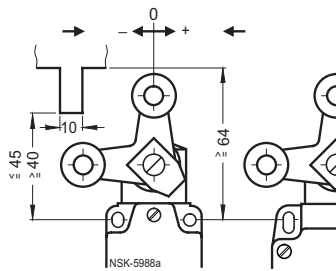

narrow enclosure

wide enclosure

perpendicular to plunger axis

$v_{max} = 2$ m/s

Snap-action contacts

1 NO + 1 NC

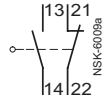

3SE3 000-1A

Identification number 11

Deflection of fork lever in direction of rotation

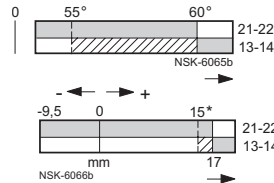

30 N

Overtravel plunger

(perpendicular to the plunger axis)

3SE3 120-1XP

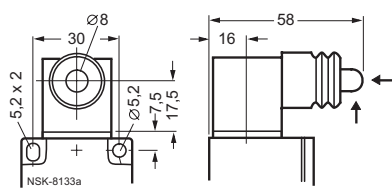

$v_{max} = 1$ m/s

Snap-action contacts

1 NO + 1 NC

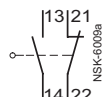

Identification number 11

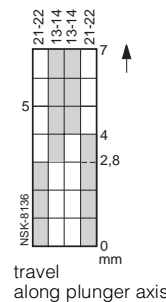

travel along plunger axis

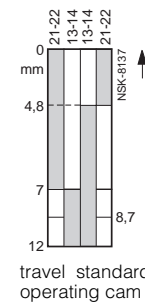

travel standard operating cam (30°)

30 N

Roller plunger

with roller in vertical position (perpendicular to the plunger axis)

3SE3 120-1XQ

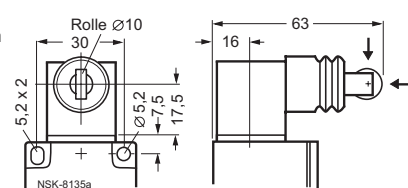

$v_{max} = 1$ m/s

Snap-action contacts

1 NO + 1 NC

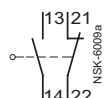

Identification number 11

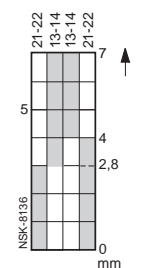

travel along plunger axis

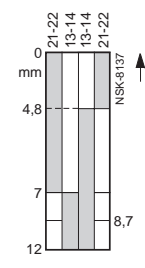

travel standard operating cam (30°)

30 N

Roller plunger

with roller in horizontal position (perpendicular to the plunger axis)

3SE3 120-1XR

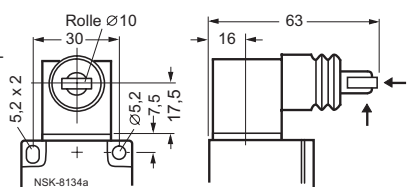

$v_{max} = 1$ m/s

Snap-action contacts

1 NO + 1 NC

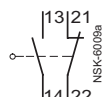

Identification number 11

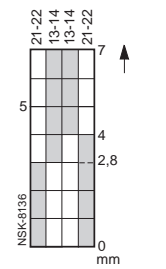

travel along plunger axis

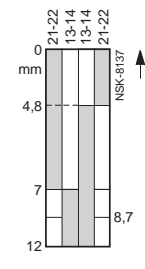

travel standard operating cam (30°)

30 N

3SE3 303 SIGUARD Position Switches

Metal-Enclosed



Operation, operating speed and travel or angle

3 contacts · Wide enclosure

Actuator	Operation by a bar	Switch block	Nominal travel and related terminal	Minimum force required in direction of operation
○	operating point acc. to EN 50 041	Internal circuit diagram	0-line reference line acc. to EN 50 041	Minimum force required in direction of operation
v_{max}	max. operating speed	Terminal designation acc. to EN 50 013	S contact closed	
H	travel difference		□ contact open	
→	direction of operation		** positive opening acc. to IEC 60 947-5-1-3	

Plunger

(made from CrNi)
3SE3 303-B

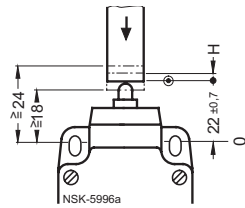

$v_{max} = 1.5$ m/s

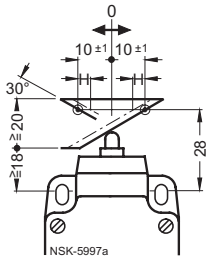

$v_{max} = 0.5$ m/s

Slow-action contacts

1 NO + 2 NC

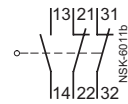

Identification number 12

along plunger axis

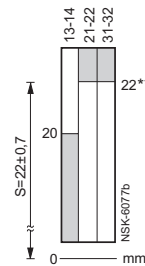

perpendicular to plunger axis

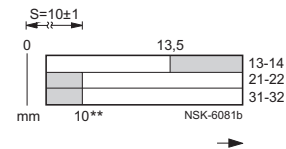

16 N

2 NO + 1 NC

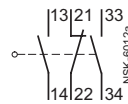

Identification number 21

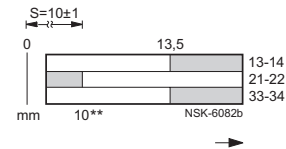
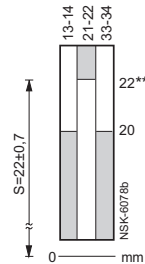

18 N

with make-before-break

1 NO + 2 NC

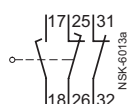

Identification number 12

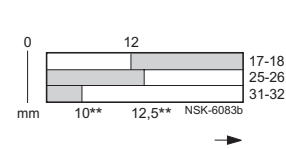
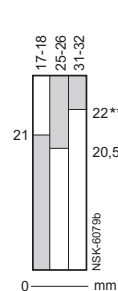

16 N

2 NO + 1 NC

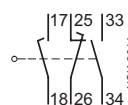

Identification number 21

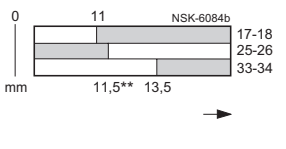
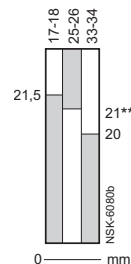

18 N



3SE3 303 SIGUARD Position Switches Metal-Enclosed

Operation, operating speed and travel or angle

3 contacts · Wide enclosure

Actuator	Operation by a bar	Switch block	Nominal travel and related terminals	Minimum force required in direction of operation
	<ul style="list-style-type: none"> ⊙ operating point acc. to EN 50 041 v_{max} max. operating speed H travel difference → direction of operation 	<ul style="list-style-type: none"> Internal circuit diagram Terminal designation acc. to EN 50 013 	<ul style="list-style-type: none"> 0-line reference line acc. to EN 50 041 S travel acc. to EN 50 041 ■ contact closed □ contact open ** positive opening to IEC 60 947-5-1-3 	

Overtravel plunger

(made from CrNi)
3SE3 303-C

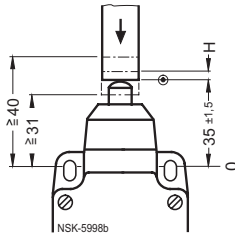

$v_{max.} = 1.5 \text{ m/s}$

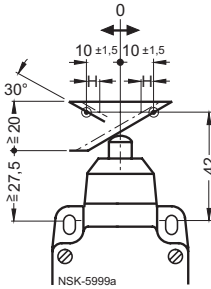

$v_{max.} = 0.5 \text{ m/s}$

Slow-action contacts

1 NO + 2 NC

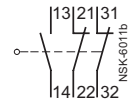

Identification number **12**

along plunger axis

perpendicular to plunger axis

35 N

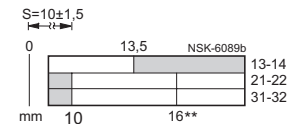
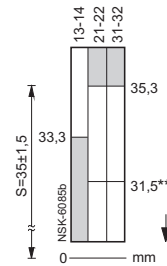

2 NO + 1 NC

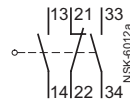

Identification number **21**

37 N

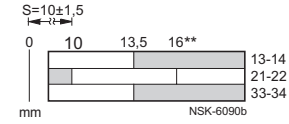
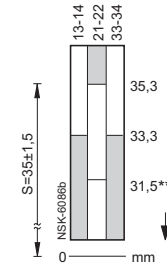

with make-before-break

1 NO + 2 NC

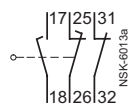

Identification number **12**

35 N

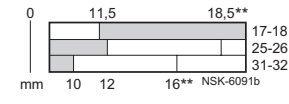
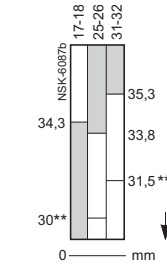

2 NO + 1 NC

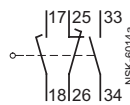

Identification number **21**

37 N

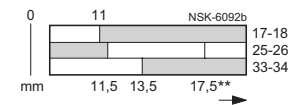
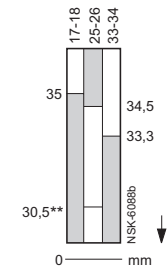

3SE3 303 SIGUARD Position Switches

Metal-Enclosed



Operation, operating speed and travel or angle

3 contacts · Wide enclosure

Actuator	Operation by a bar	Switch block	Nominal travel and related terminals	Minimum force required in direction of operation
⊙	operating point acc. to EN 50 041	Internal circuit diagram	O-line reference line acc. to EN 50 041	
v_{max}	max. operating speed	Terminal designation acc. to EN 50 013	S contact closed	
H	travel difference		□ contact open	
→	direction of operation	** positive opening to IEC 60 947-5-1-3		

Roller plunger

(roller made from brass on a steel spindle)

3SE3 303-D

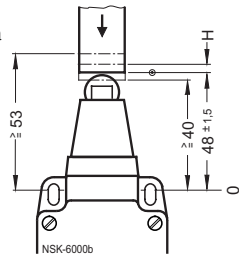

$v_{max} = 1.5$ m/s

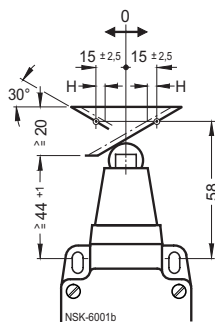

$v_{max} = 1$ m/s

Slow-action contacts

along plunger axis perpendicular to plunger axis

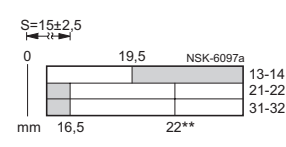
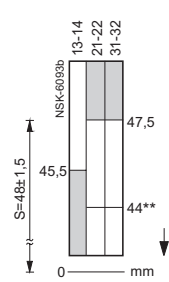
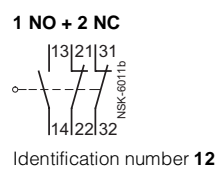

35 N

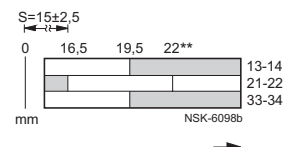
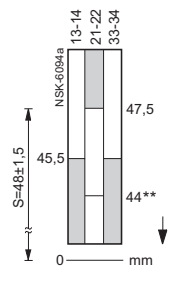
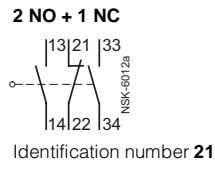

37 N

with make-before-break

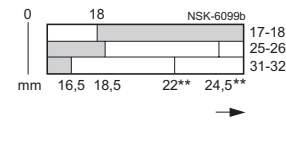
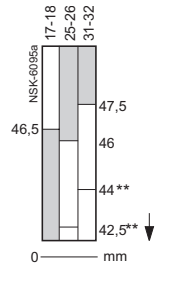
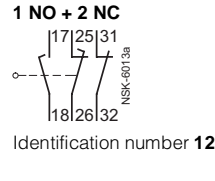

35 N

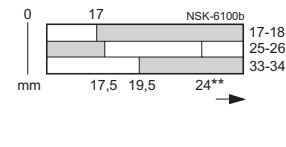
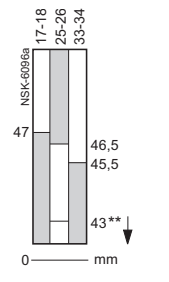
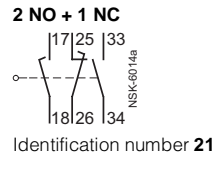

37 N



3SE3 303 SIGUARD Position Switches Metal-Enclosed

Operation, operating speed and travel or angle

3 contacts · Wide enclosure

Actuator	Operation by a bar	Switch block	Nominal travel and related terminals	Minimum force required in direction of operation
○	operating point acc. to EN 50 041	Internal circuit diagram	0-line reference line acc. to EN 50 041	Minimum force required in direction of operation
H	travel difference	Terminal designation acc. to EN 50 013	S travel acc. to EN 50 041	
α	max. approach angle		■ contact closed	
γ	max. approach angle		□ contact open	
β	max. trailing angle		** positive opening to IEC 60 947-5-1-3	
v _{max.}	max. operating speed			
→	direction of operation			

Roller lever

(roller made from moulded plastic)

3SE3 303-E

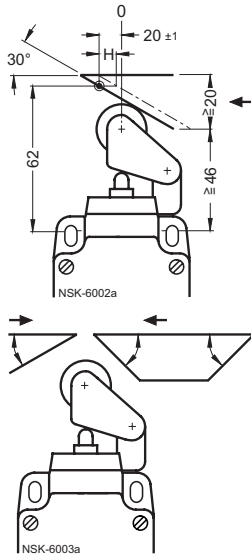

For operation perpendicular to plunger axis
 $\alpha_{max.} = 30^\circ$, $v_{max.} = 1 \text{ m/s}$
 $\gamma_{max.} = 45^\circ$, $v_{max.} = 2.5 \text{ m/s}$
 $\beta_{max.} = 45^\circ$
 For operation along plunger axis
 $v_{max.} = 1.5 \text{ m/s}$

Slow-action contacts

1 NO + 2 NC

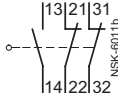

Identification number 12

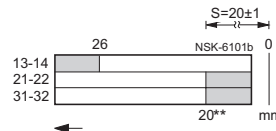

15 N

2 NO + 1 NC

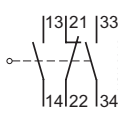

Identification number 21

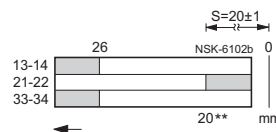

17 N

with make-before-break

1 NO + 2 NC

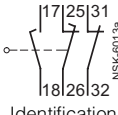

Identification number 12

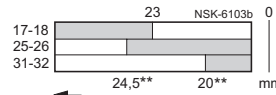

15 N

2 NO + 1 NC

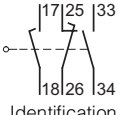

Identification number 21

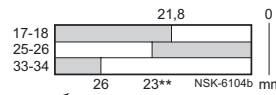

17 N

Angular roller lever

(roller made from moulded plastic)

3SE3 303-F

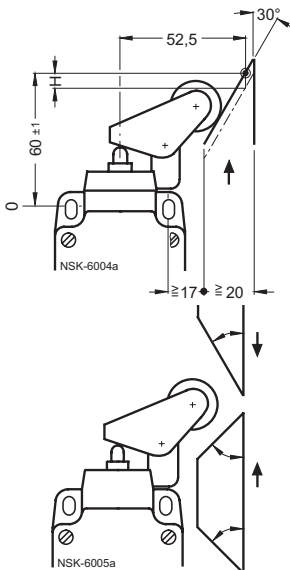

For operation along plunger axis
 $\alpha_{max.} = 30^\circ$, $v_{max.} = 1 \text{ m/s}$
 $\gamma_{max.} = 45^\circ$, $v_{max.} = 2.5 \text{ m/s}$
 $\beta_{max.} = 45^\circ$, $v_{max.} = 2.5 \text{ m/s}$

Slow-action contacts

1 NO + 2 NC

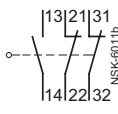

Identification number 12

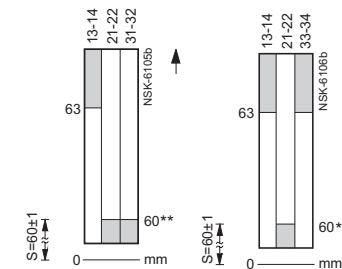

15 N

2 NO + 1 NC

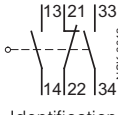

Identification number 21



17 N

with make-before-break

1 NO + 2 NC

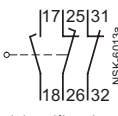

Identification number 12

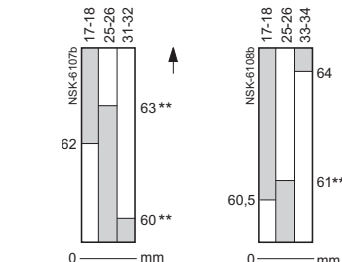

15 N

2 NO + 1 NC

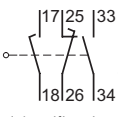

Identification number 21



17 N

3SE3 303 SIGUARD Position Switches Metal-Enclosed



Operation, operating speed and travel or angle

3 contacts · Wide enclosure

Actuator	Operation by a bar	Switch block	Nominal travel and related terminals	Minimum force required in direction of rotation
⊖	operating point acc. to EN 50 041	Internal circuit diagram	0-line reference line acc. to EN 50 041	
V _{max.}	max. operating speed	Terminal designation acc. to EN 50 013	S travel acc. to EN 50 041	
H	travel difference		■ contact closed	
→	direction of operation		□ contact open	
			** positive opening to IEC 60 947-5-1-3	

Roller crank Slow-action contacts

repositionable and finely adjustable from 10° to 10° (roller made from moulded plastic)

3SE3 ...-GW-Z A31

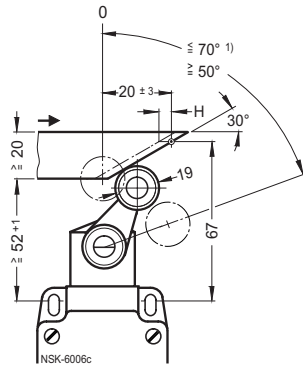

V_{max.} = 3 m/s

Contact operation either from right or left or from right and left.

perpendicular to plunger axis

25 Ncm

1 NO + 2 NC

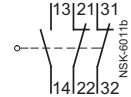

Identification number **12**

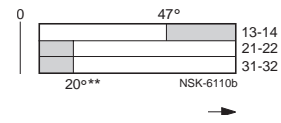
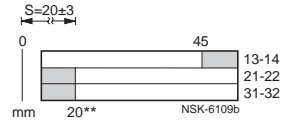

2 NO + 1 NC

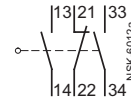

Identification number **21**

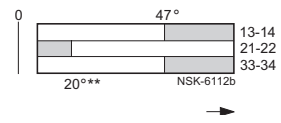
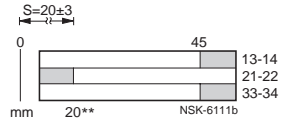

with make-before-break

1 NO + 2 NC

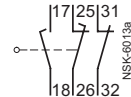

Identification number **12**

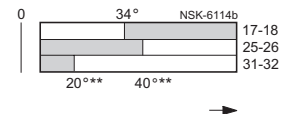
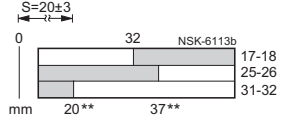

2 NO + 1 NC

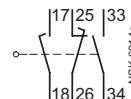

Identification number **21**

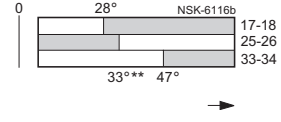
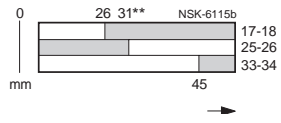

1) Max. operating angle 70°, max. deflection for adjustment purposes 90°.



3SE3 303 SIGUARD Position Switches Metal-Enclosed

Operation, operating speed and travel or angle

3 contacts · Wide enclosure

Actuator	Operation by a bar	Switch block	Nominal travel and related terminals	Minimum force required in direction of rotation
⊙	operating point acc. to EN 50 041	Internal circuit diagram	0-line reference line acc. to EN 50 041	
α	max. approach angle	Terminal designation acc. to EN 50 013	S travel acc. to EN 50 041	
β	max. trailing angle		■ contact closed	
$v_{max.}$	max. operating speed		□ contact open	
**	max. bar distance or angle to ensure positive opening of snap-action contacts acc. to DIN VDE 0113		** positive opening to IEC 60 947-5-1-3	
→	direction of operation			

Roller crank

repositionable and finely adjustable from 10° to 10° (roller made from moulded plastic)

3SE3 303-UW

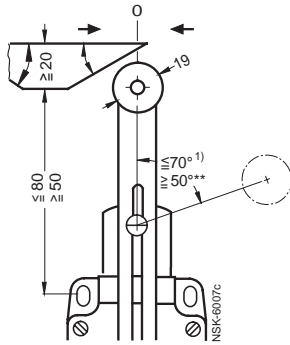

$\alpha_{max.} = 30^\circ$
 $\beta_{max.} = 30^\circ$
 $v_{max.} = 3 \text{ m/s}$

Contact operation either from right or left or from right and left.

Slow-action contacts

Deflection of roller crank or rod actuator in direction of rotation

25 Ncm

1 NO + 2 NC

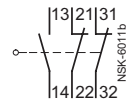

Identification number 12

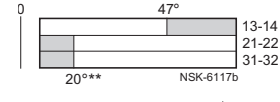

2 NO + 1 NC

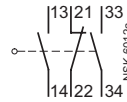

Identification number 21

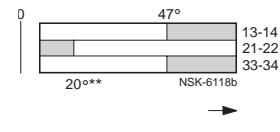

with make-before-break

1 NO + 2 NC

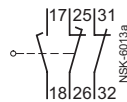

Identification number 12

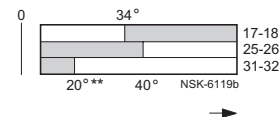

2 NO + 1 NC

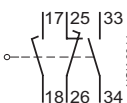

Identification number 21

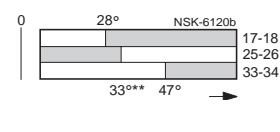

1) Max. operating angle 70°.

3SE3 SIGUARD Position Switches Metal-Enclosed/Open-Type



Operation, operating speed and travel or angle

3SE3 303 metal-enclosed position switches · 3 contacts · Wide enclosure

Actuator	Operation by a bar	Switch block	Nominal travel and related terminals	Minimum force required in direction of rotation
	v_{max} max. operating speed → direction of operation	Internal circuit diagram Terminal designation acc. to EN 50 013	0-line reference line acc. to EN 50 041 ■ contact closed □ contact open ** positive opening to IEC 60 947-5-1-3	

Rod actuator

finely adjustable from 10° to 10° (rod made from moulded plastic or aluminium)

3SE3 303-WW
3SE3 303-VW

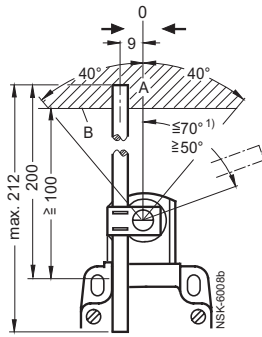

A switching range
B bottom edge of actuating device

$v_{max} = 3$ m/s

Contact operation either from right or left or from right and left.

1) Max. operating angle 70°, max. deflection for adjustment purposes 90°.

Slow-action contacts

Deflection of roller crank or rod actuator in direction of rotation

25 Ncm

1 NO + 2 NC

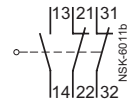

Identification number 12

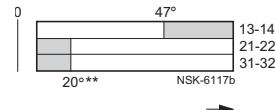

2 NO + 1 NC

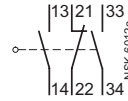

Identification number 21

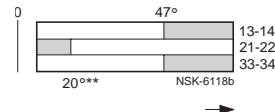

with make-before-break

1 NO + 1 NC

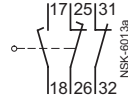

Identification number 12

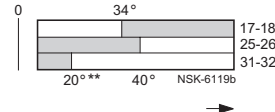

2 NO + 1 NC

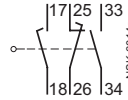

Identification number 21

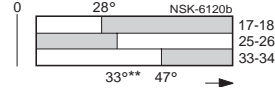

3SE3 404 metal-enclosed position switches · 4 contacts · Wide enclosure

The data for operation, operating speed, travel and angle of operation is the same as for the metal-enclosed position switches with 2 contact blocks. Contact blocks with 2 contacts are used for position switches with 4 contacts.

3SE3 020 and 3SE3 023 open-type position switches

2 and 3 contacts · Moving double break contacts · Degree of protection: Terminals IP 20, switching chamber IP 40

Actuator	Operation	Type	A ≥ mm	A** ≤ mm	
Plunger (made from CrNi)		Actuators can be in the form of an actuating bar, cam, stop etc.	3SE3 020-0A	15	–
		For operation perpendicular to plunger axis	3SE3 020-1A	15	17.5
		$\alpha_{max} = 30^\circ$, $v_{max} = 0.5$ m/s	3SE3 020-3A	15	–
		$\beta_{max} = 30^\circ$			
		For operation along plunger axis			
		$v_{max} = 1.5$ m/s			
A	actuating bar distance = Distance from the middle of the mounting holes to the lower edge of the actuating bar	3SE3 023-0A	15	–	
		3SE3 023-1A	15	–	
		3SE3 023-2A	15	–	
A**	Actuating bar distance, to guarantee positive opening of the snap-action contacts acc. to DIN VDE 0113.	3SE3 023-3A	15	–	